

Standard & Armless

(All 4 seat items ship as one piece if stationary, two pieces if motion installed)

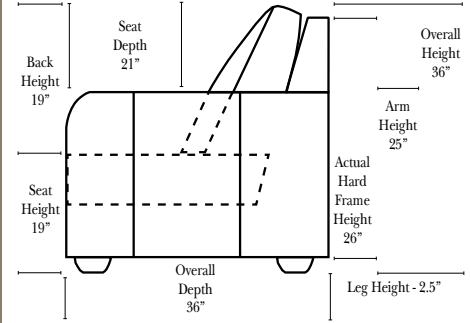
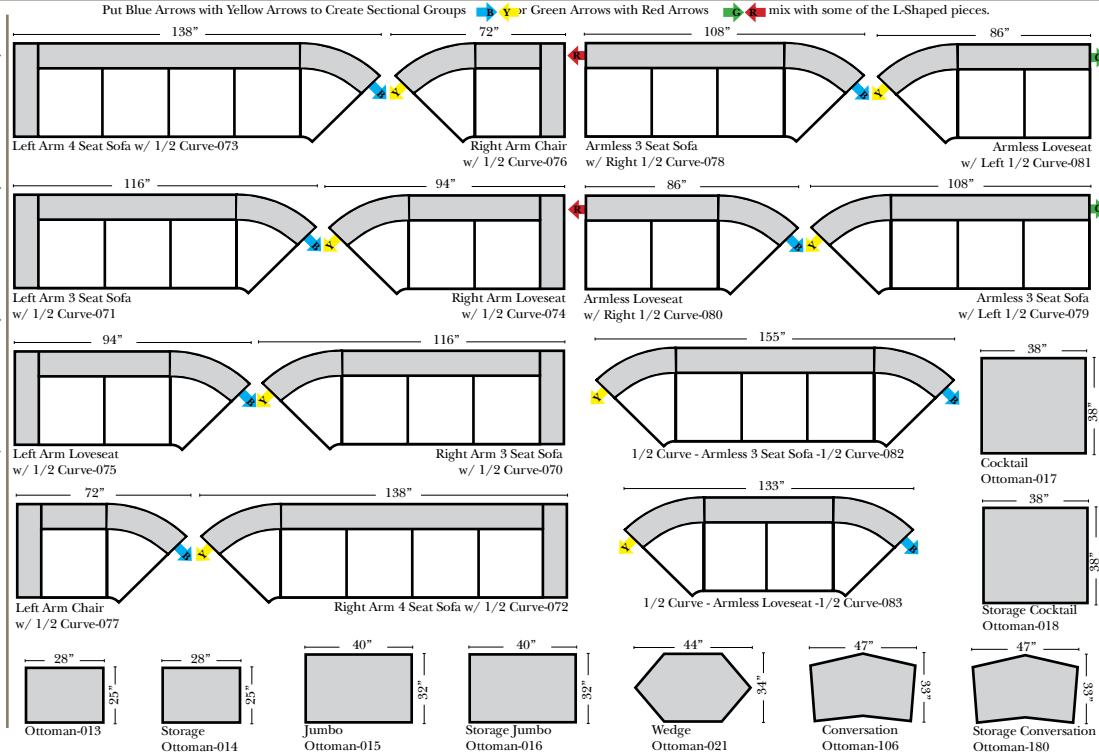
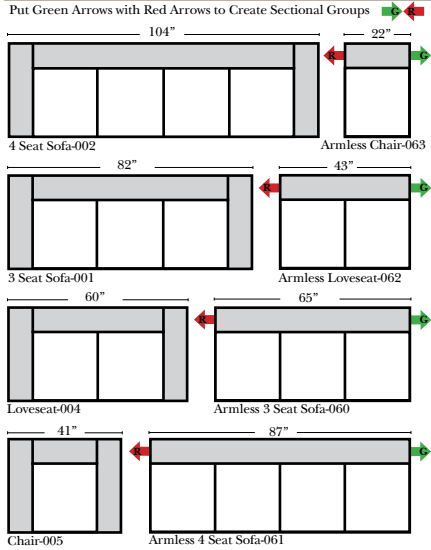

Features

- Standard:**
- Available in Full & Top Grain Leathers
 - Available in Luxury Fabrics
 - All Hardwood Frames
 - Nail Heads
 - Legs are standard as Walnut color, available in Cherry, Espresso, Honey Oak, & Natural

- Options:**
- Down Seats & Backs (additional Charge)
 - No. 33 Firm Foam

- Sleeper Options:** (All the below options are at additional charges)
- Full Sleeper available w/ Standard Mattress
 - Deluxe Innerspring Mattress: Full
 - Air Dream Coil Mattress: Full Only

L-Shape / 90 Degree Sectional

(All 4 seat items ship as one piece if stationary, two pieces if motion installed)

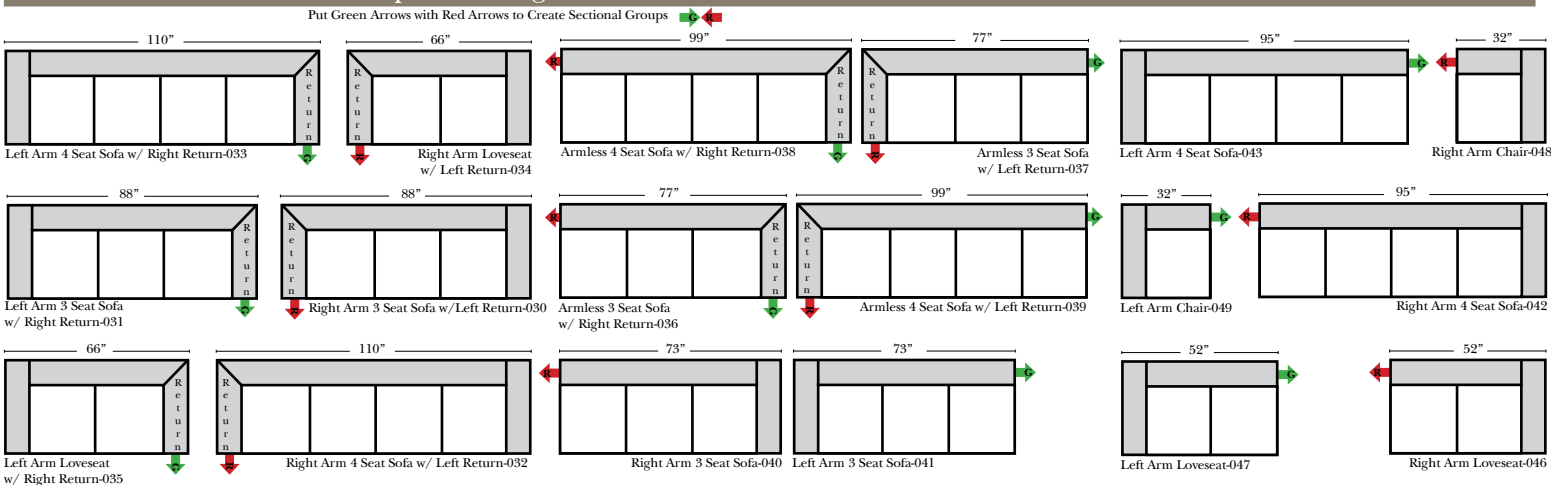



Note:

All Dimensions are approximate, if accuracy is crucial, please contact us for validation of the dimensions shown. However, a 1" to 2" variance can still apply due to foam and upholstery.



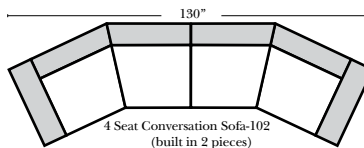
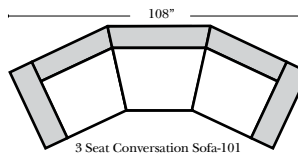
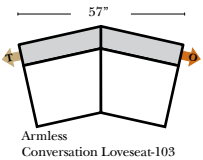
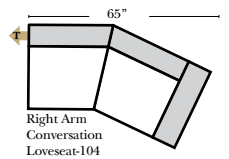
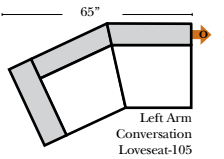
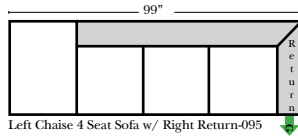
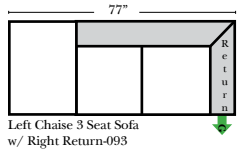
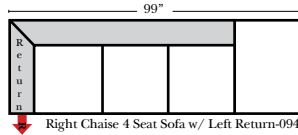
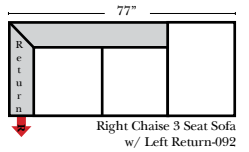
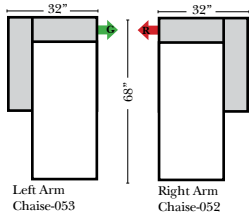

Chaise & Conversation Sectionals

Put Green Arrows with Red Arrows to Create Sectional Groups 
Put Orange Arrows with Tan Arrows to Create Sectional Groups 



Sleepers

Put Green Arrows with Red Arrows to Create Sectional Groups 
Put Blue Arrows with Yellow Arrows to Create Sectional Groups 

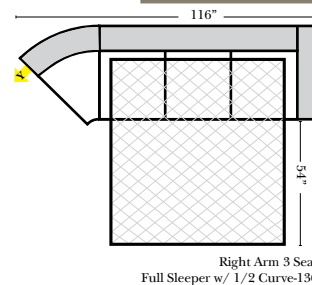
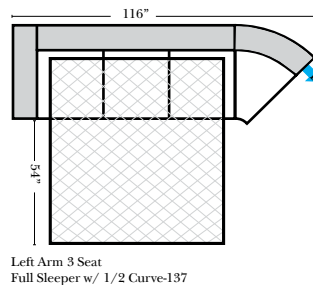
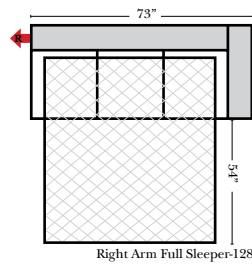
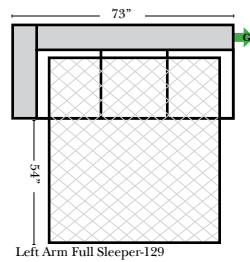
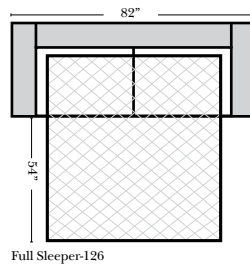

Suggested Configurations

07/06/2012

The Suggested Configurations below are only a sample of what the imagination can create, please enjoy creating the configuration that fits your lifestyle, using the ideas below and from the items on the opposite page.

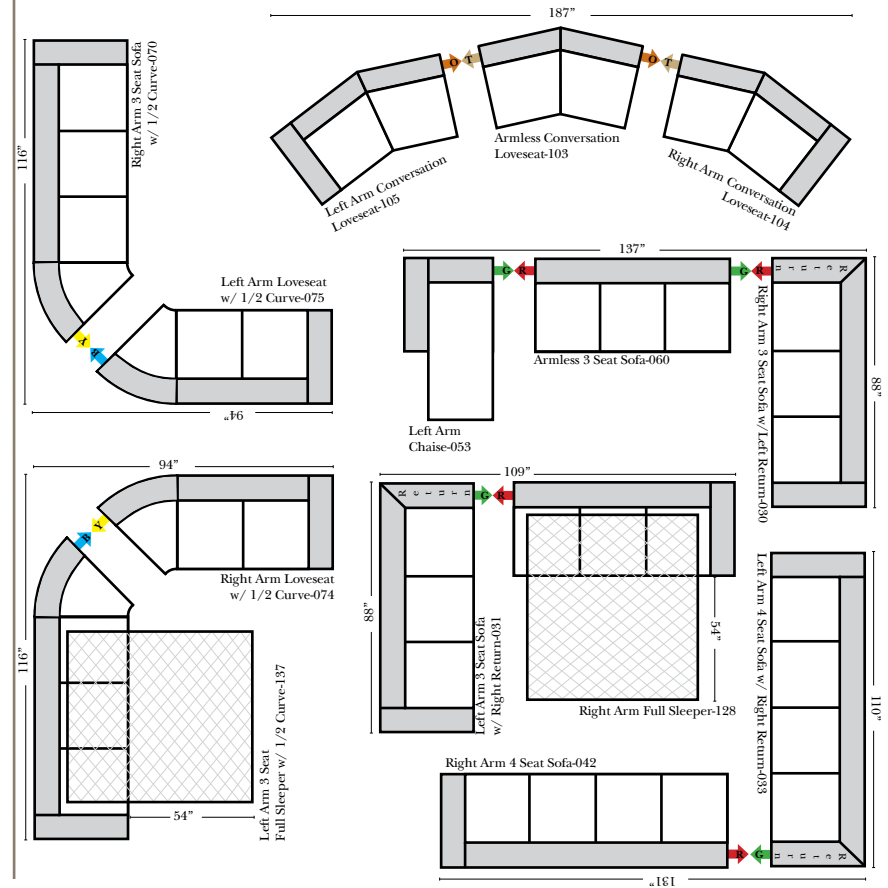

Sleepers (Cont.)