

Standard & Armless (All 4 seat items ship as one piece if stationary, two pieces if motion installed)

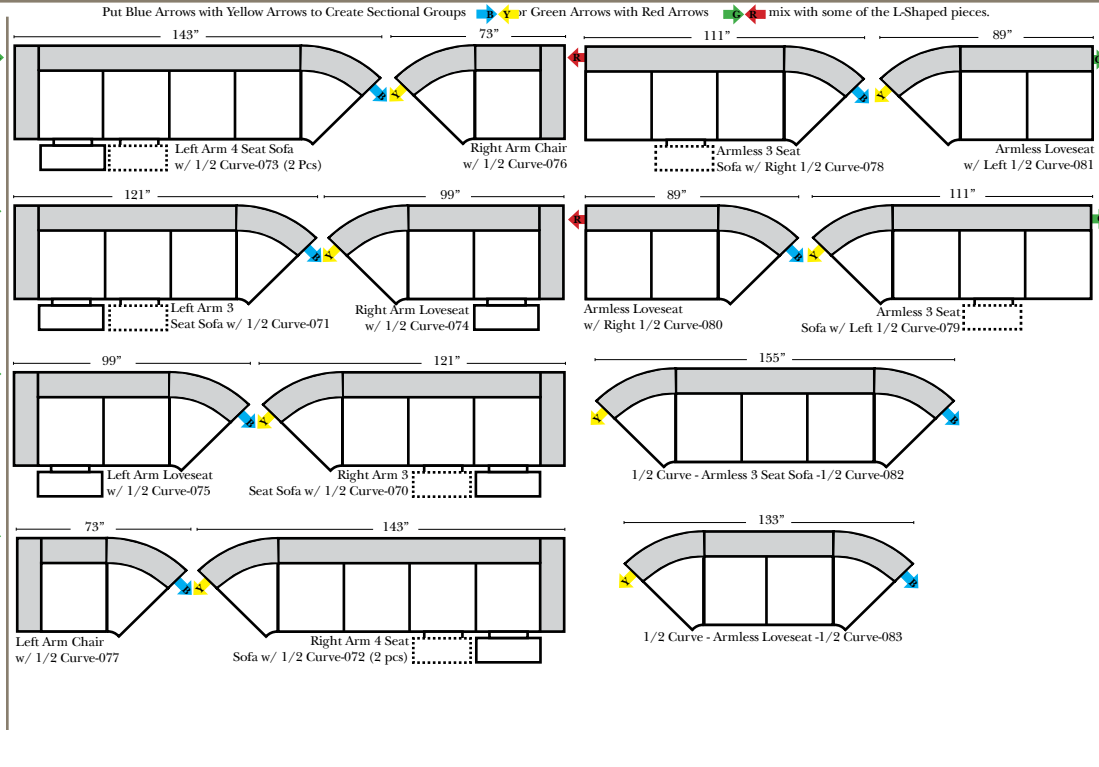

2 Piece Curve Sectional & Ottomans

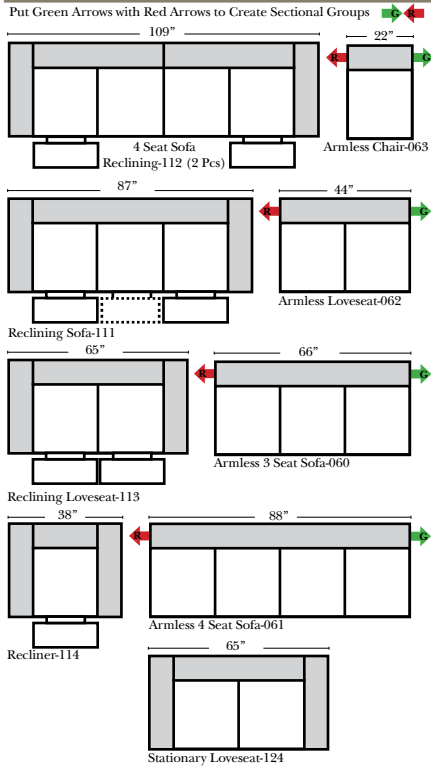
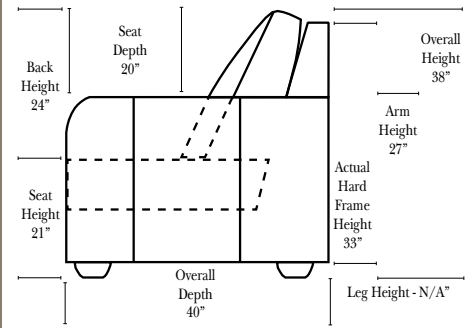

Features

- Standard:**
- Available in Full & Top Grain Leathers
 - Available in Luxury Fabrics
 - All Hardwood Frames
- Options:**
- No. 33 Firm Foam (N/C Option)
 - Console Table - Standard as Espresso finish (N/C Option is Honey Oak finish)
 - Cup Holders - Standard as Silver finish (N/C Option is Black or Hammered Antique Finish)
 - Sofa Center Recliner (Additional Charge)
 - Motorized Recliner Mechanism (additional Charge)
 - Swivel Recliner Base (additional Charge)
 - Swivel Glider Mechanism (additional Charge)
 - Lift Chair Dual Motor Mechanism (additional Charge)
- Sleeper Options:** (All the below options are at additional charges)
- Full Sleeper available w/Standard Mattress
 - Deluxe Innerspring Mattress: Full
 - Air Dream Coil Mattress: Full Only

L-Shape / 90 Degree Sectional

(All 4 seat items ship as one piece if stationary, two pieces if motion installed)

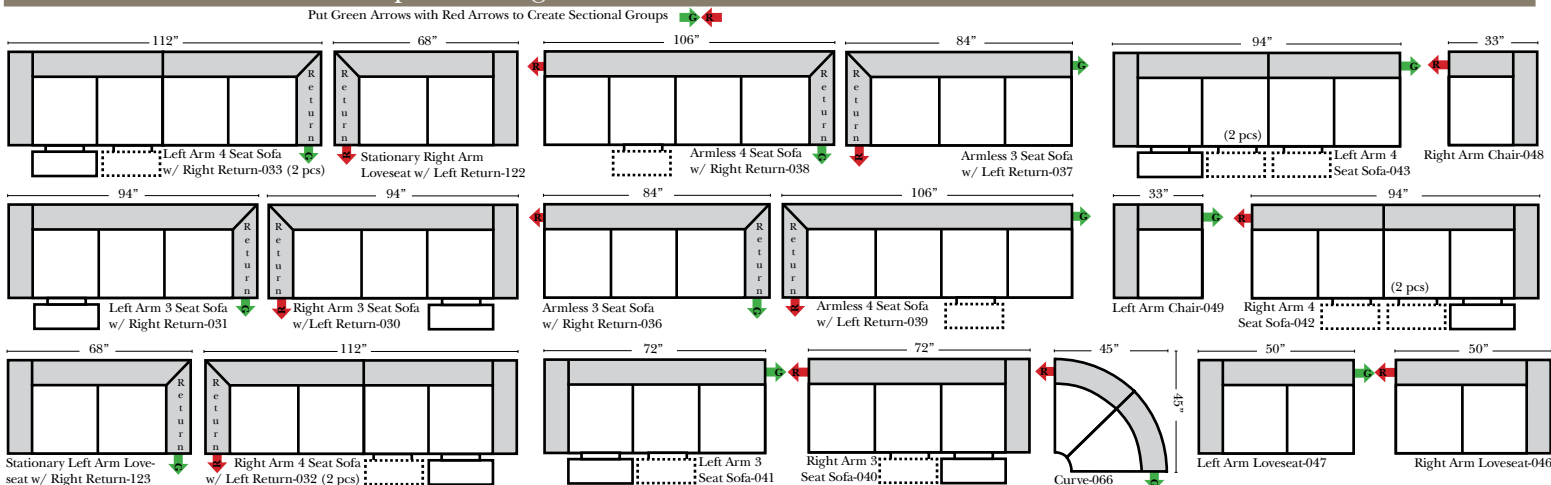

Note:

All Dimensions are approximate, if accuracy is crucial, please contact us for validation of the dimensions shown. However, a 1" to 2" variance can still apply due to foam and upholstery.



Chaise & Conversation Sectionals

Put Green Arrows with Red Arrows to Create Sectional Groups
Put Orange Arrows with Tan Arrows to Create Sectional Groups

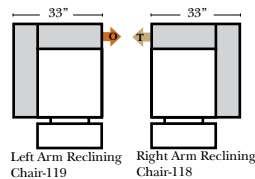
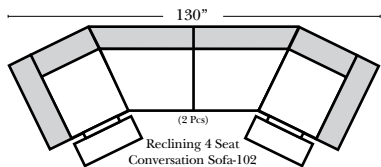
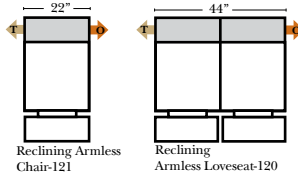
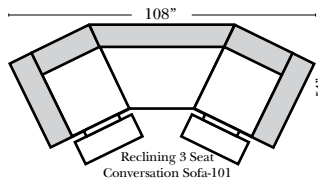
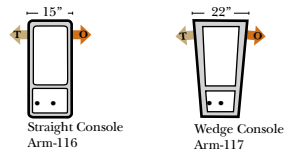
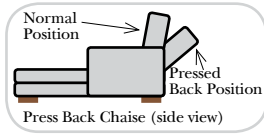
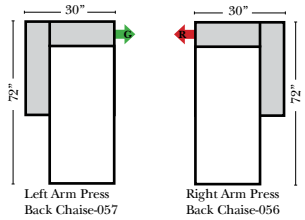

Sleepers

Put Green Arrows with Red Arrows to Create Sectional Groups
Put Blue Arrows with Yellow Arrows to Create Sectional Groups

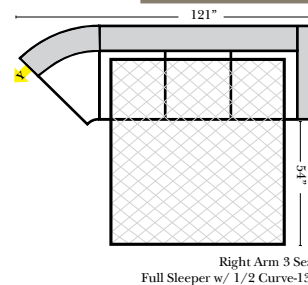
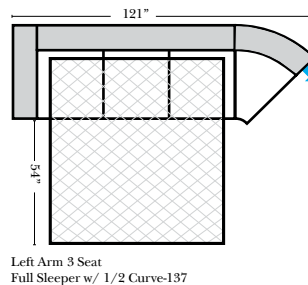
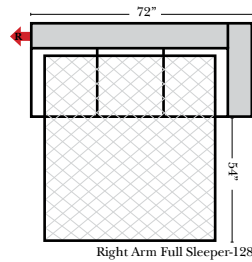
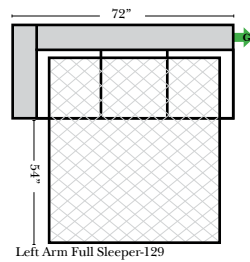
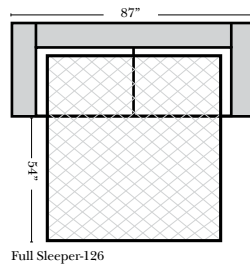

Suggested Configurations

07/06/2012

The Suggested Configurations below are only a sample of what the imagination can create, please enjoy creating the configuration that fits your lifestyle, using the ideas below and from the items on the opposite page.

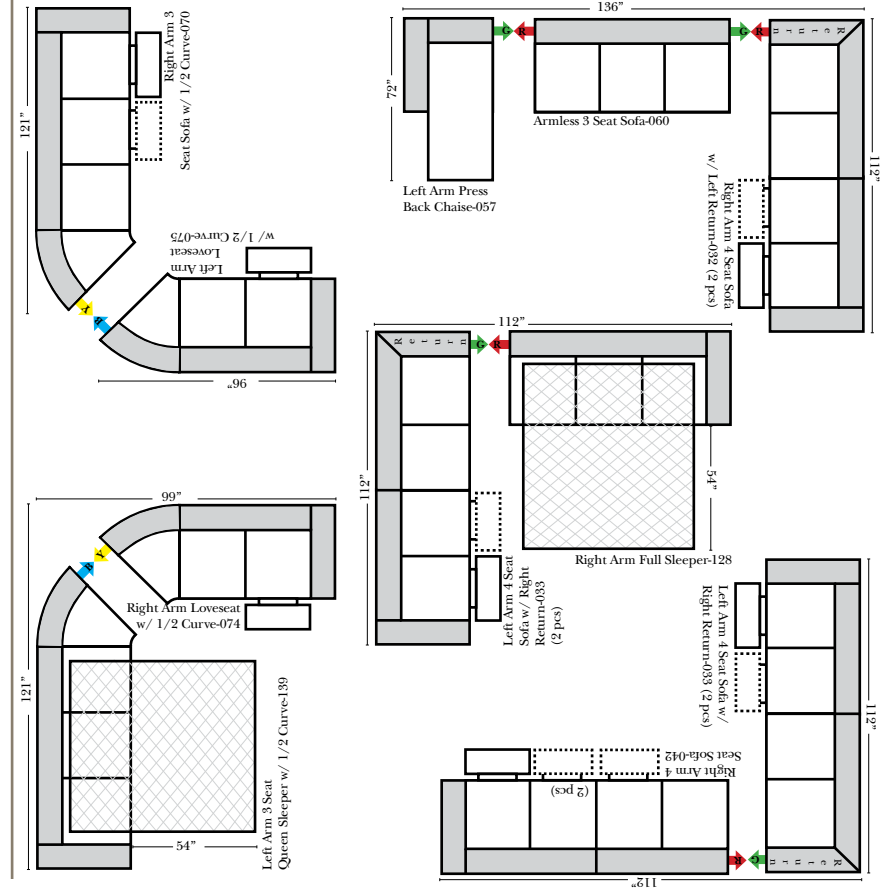

Sleepers (Cont.)