

Standard & Armless

(All 4 seat items ship as one piece if stationary, two pieces if motion installed)

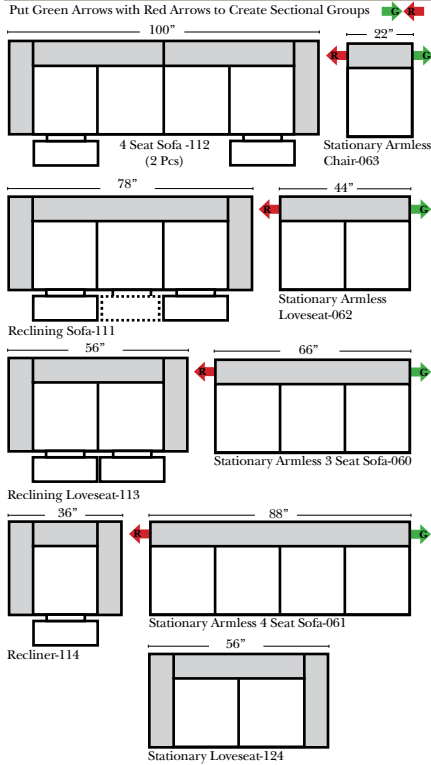

2 Piece Curve Sectional & Ottomans

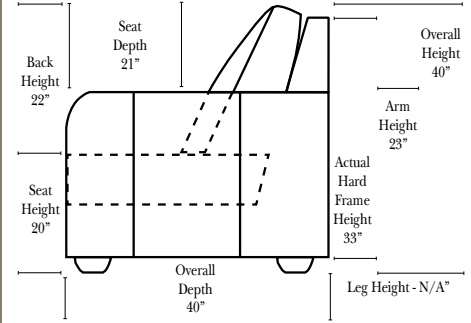
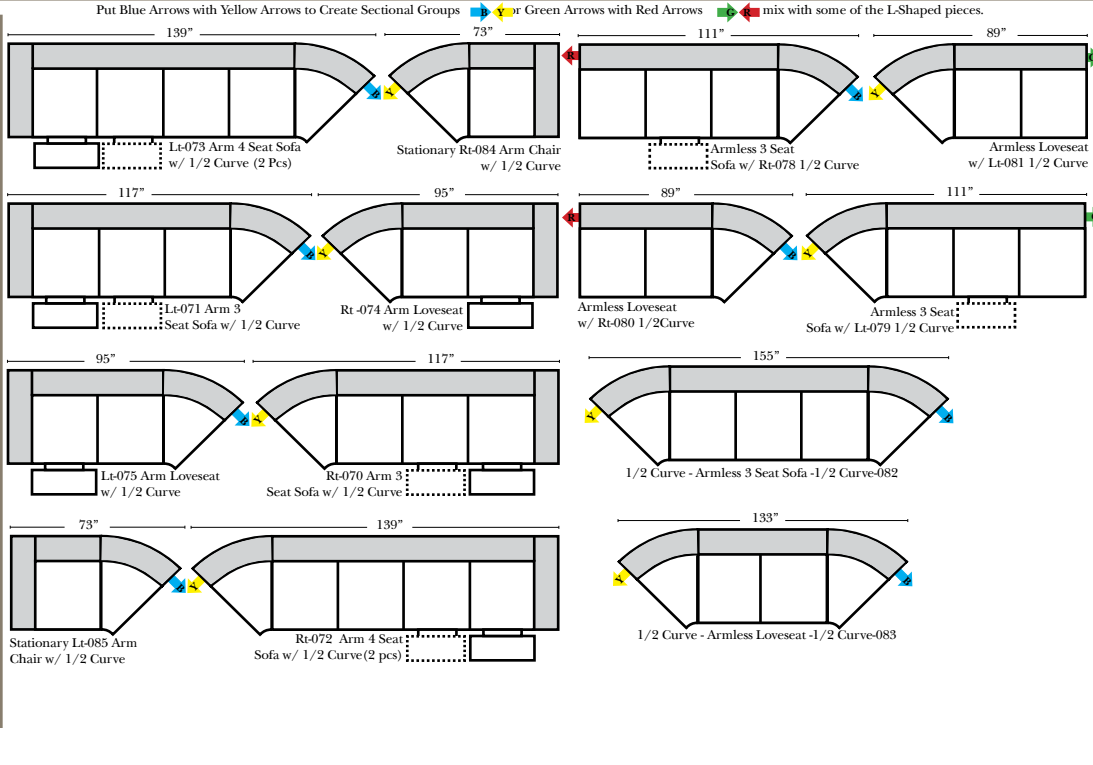

Features

- Standard:**
- Available in Full & Top Grain Leathers
 - Available in Luxury Fabrics
 - All Hardwood Frames
- Options:**
- No. 33 Firm Foam (N/C Option)
 - Console Table - Standard as Espresso finish (N/C Option is Honey Oak finish)
 - Cup Holders - Standard as Silver finish (N/C Option is Black or Hammered Antique Finish)
 - Sofa Center Recliner (Additional Charge)
 - Motorized Recliner Mechanism (additional Charge)
 - Swivel Recliner Base (additional Charge)
 - Swivel Glider Mechanism (additional Charge)
 - Lift Chair Dual Motor Mechanism (additional Charge)

- Sleeper Options:** (All the below options are at additional charges)
- Full Sleeper available w/Standard Mattress
 - Deluxe Innerspring Mattress: Full
 - Air Dream Coil Mattress: Full Only

Note:



All Dimensions are approximate, if accuracy is crucial, please contact us for validation of the dimensions shown. However, a 1" to 2" variance can still apply due to foam and upholstery.

L-Shape / 90 Degree Sectional

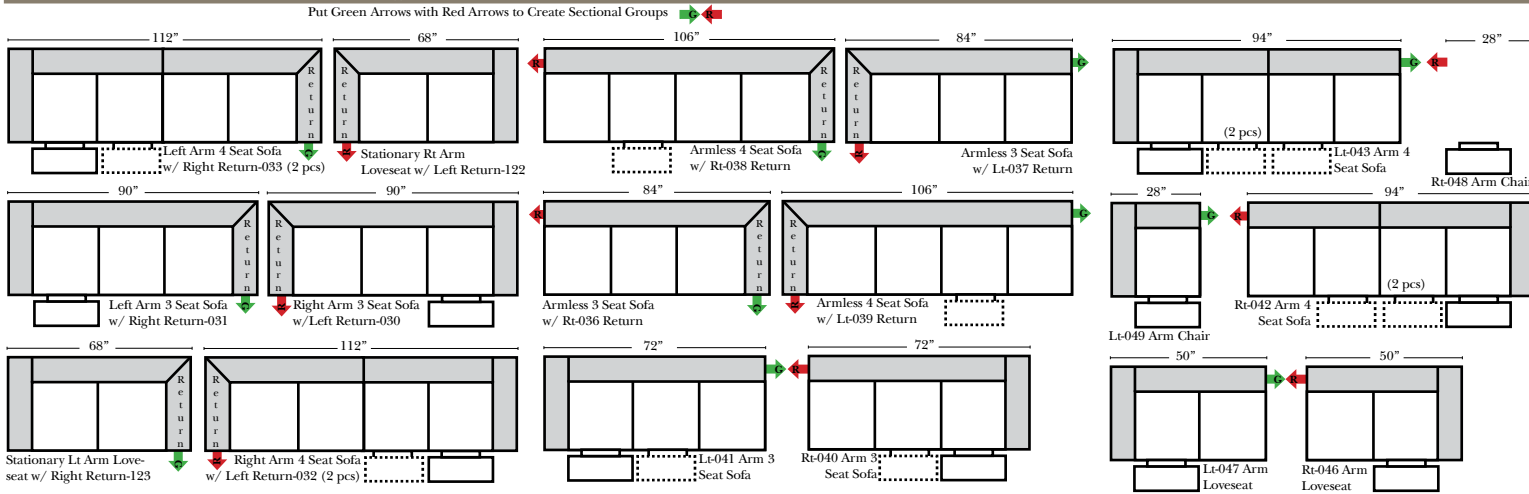
(All 4 seat items ship as one piece if stationary, two pieces if motion installed)



Chaise, Curves/Wedges & Conversation Sectionals

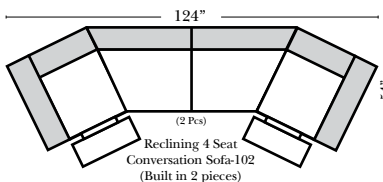
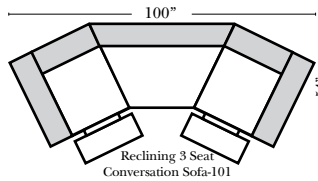
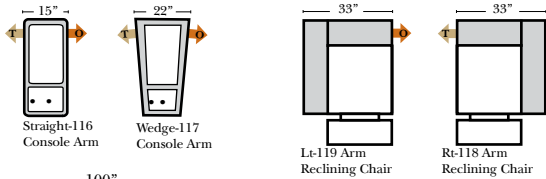
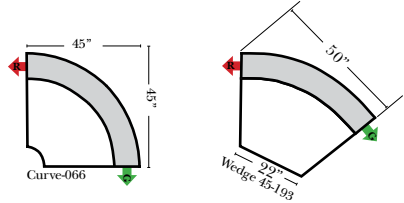
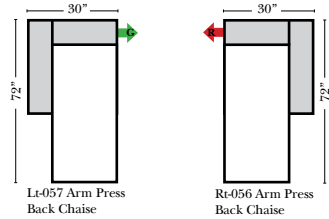

Put Green Arrows with Red Arrows to Create Sectional Groups 
Put Orange Arrows with Tan Arrows to Create Sectional Groups 

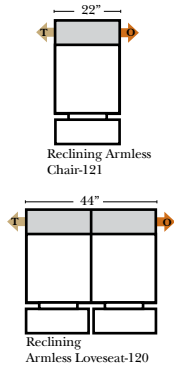

(No other configurations can be put between the 4 Seat Conversation Sofa pieces)



Sleepers

Put Green Arrows with Red Arrows to Create Sectional Groups 
Put Blue Arrows with Yellow Arrows to Create Sectional Groups 

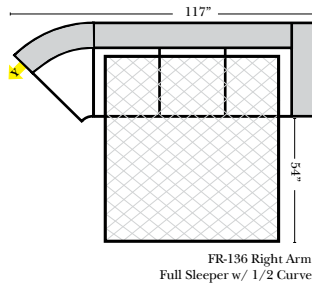
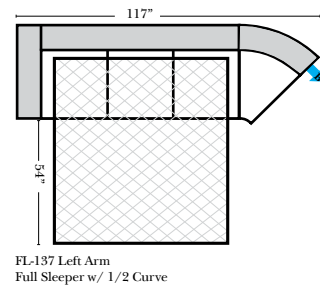
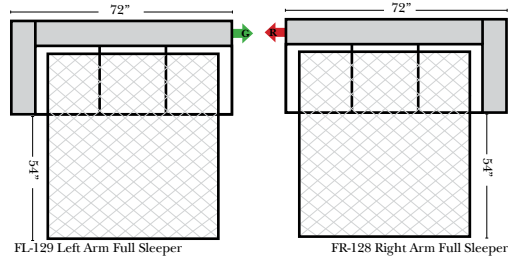
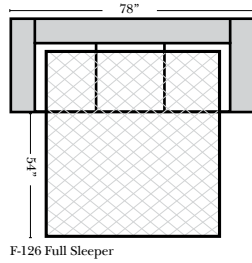

Suggested Configurations

07/06/2012

The Suggested Configurations below are only a sample of what the imagination can create, please enjoy creating the configuration that fits your lifestyle, using the ideas below and from the items on the opposite page.

