

Standard & Armless

(All 4 seat items ship as one piece if stationary, two pieces if motion installed)

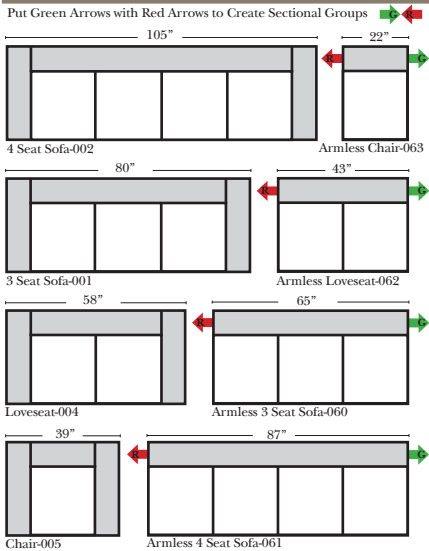

L-Shape / 90 Degree Sectional

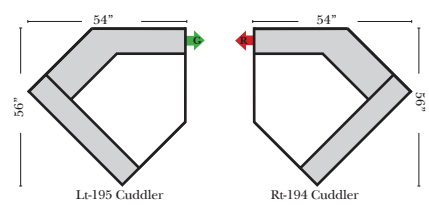

2 Piece Curve Sectional & Ottomans

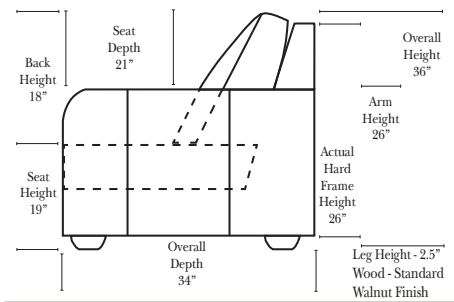
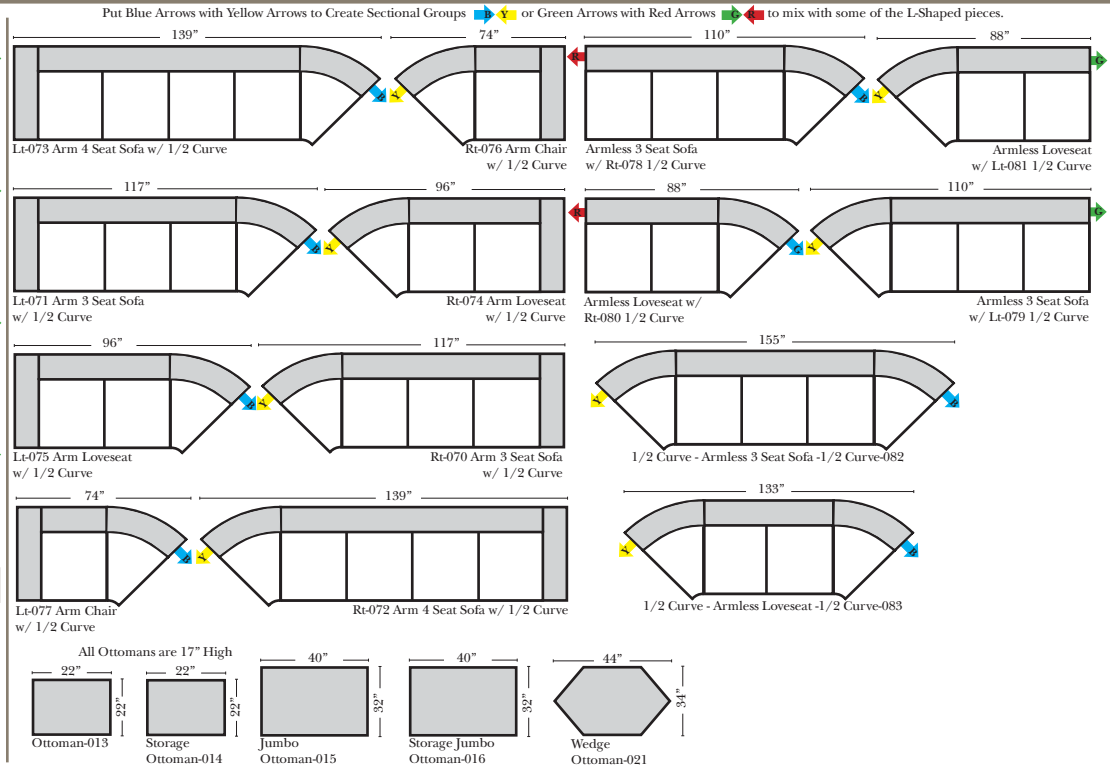

Feature & Options

- Standard:**
- Available in Full & Top Grain Leathers
 - Available in Luxury Fabrics
 - All Hardwood Frames
- Options Available with No Additional Charge:**
- No. 33 Firm Foam
 - Leg finish options - Cherry, Chocolate, Espresso, Honey Oak
- Options that have Additional Charges:**
- Add Storage to Ottoman
 - Down Seats & Down Backs (additional Charge)
 - Add Upholstered Swivel Base (2 arm Chair only)
- Sleeper Options: (Additional Charges Apply)**
- Full Sleeper available w/Standard Mattress
 - Deluxe Innerspring Mattress: Full Only
 - Air Dream Coil Mattress: Full Only

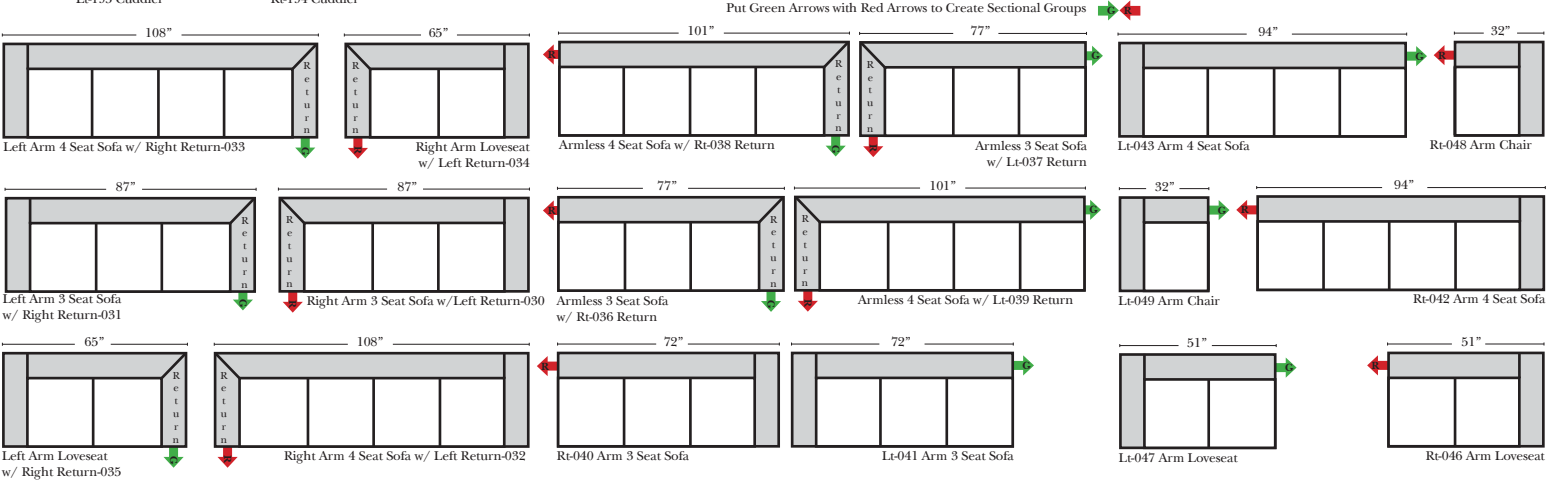

L-Shape / 90 Degree Sectional (cont.)



Note:
 All Dimensions are approximate, if accuracy is crucial, please contact us for validation of the dimensions shown. However, a 1" to 2" variance can still apply due to foam and upholstery.





Chaise & Conversation Sectionals

Put Green Arrows with Red Arrows to Create Sectional Groups 
 Put Orange Arrows with Tan Arrows to Create Sectional Groups 

Chaises
 for this style not available
 at this time

Conversation Sectionals
 for this style not available
 at this time

Sleepers

Put Green Arrows with Red Arrows to Create Sectional Groups 
 Put Blue Arrows with Yellow Arrows to Create Sectional Groups 

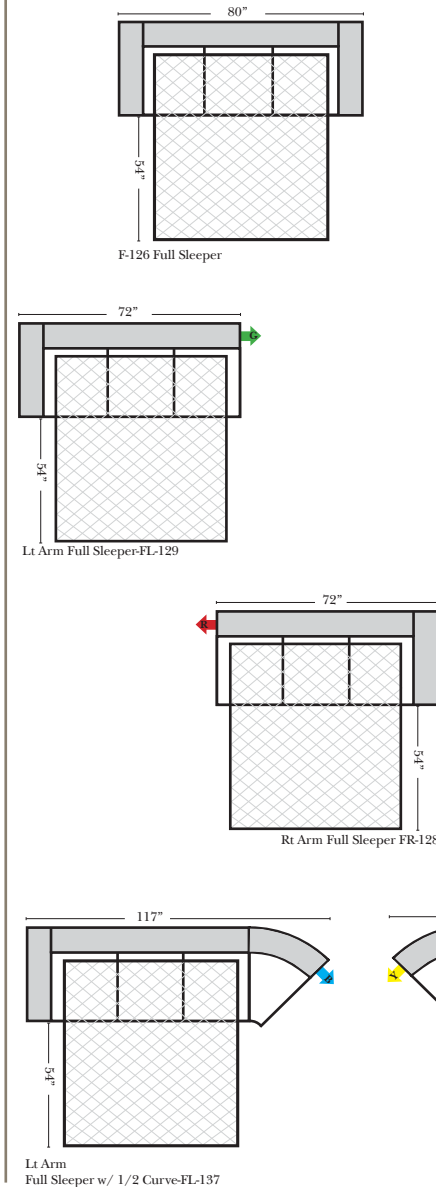

Suggested Configurations

07/06/2012

The Suggested Configurations below are only a sample of what the imagination can create, please enjoy creating the configuration that fits your lifestyle, using the ideas below and from the items on the opposite page.

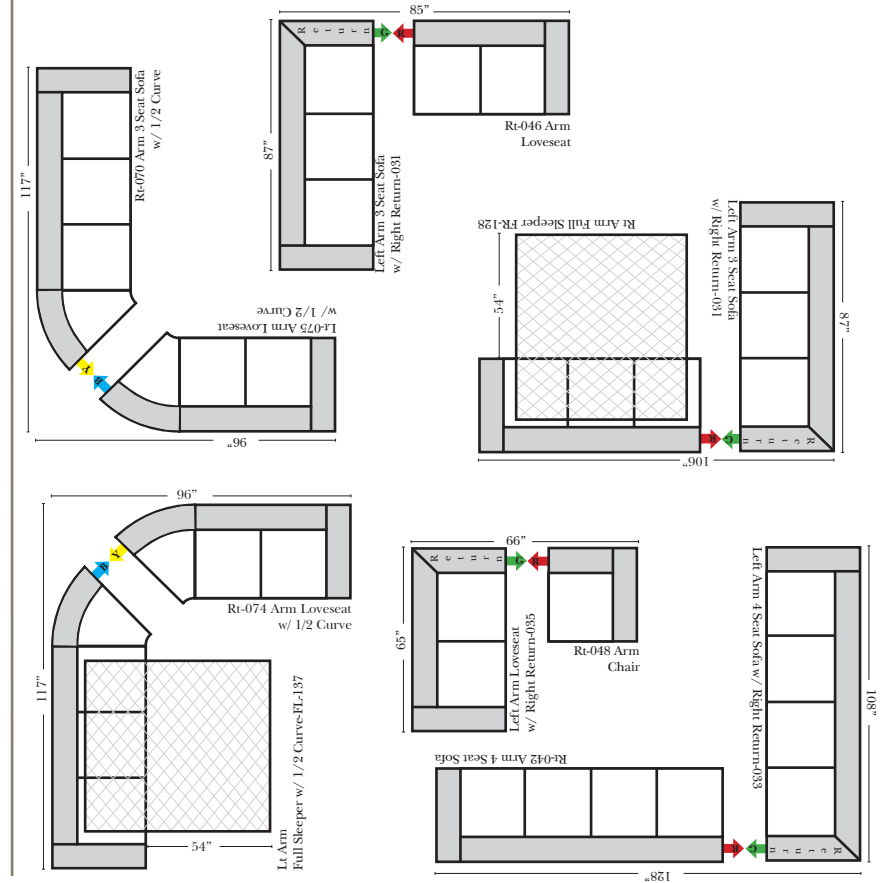

Sleepers (Cont.)