

Standard & Armless (All 4 seat items ship as one piece if stationary, two pieces if motion installed)

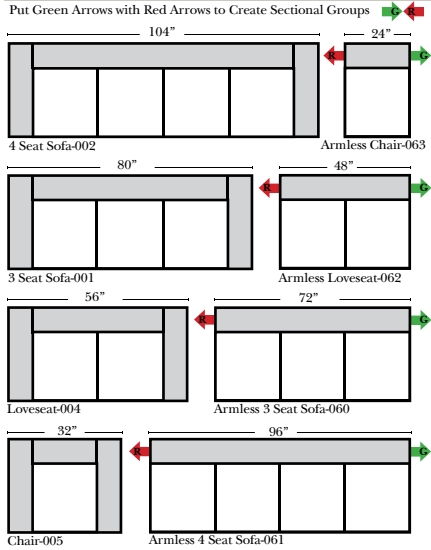

2 Piece Curve Sectional & Ottomans

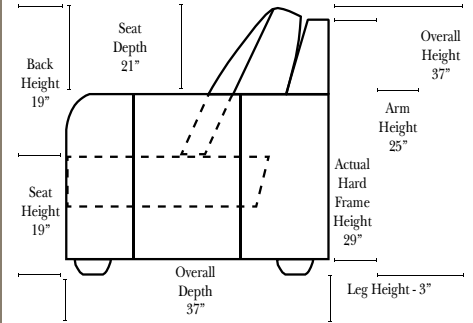
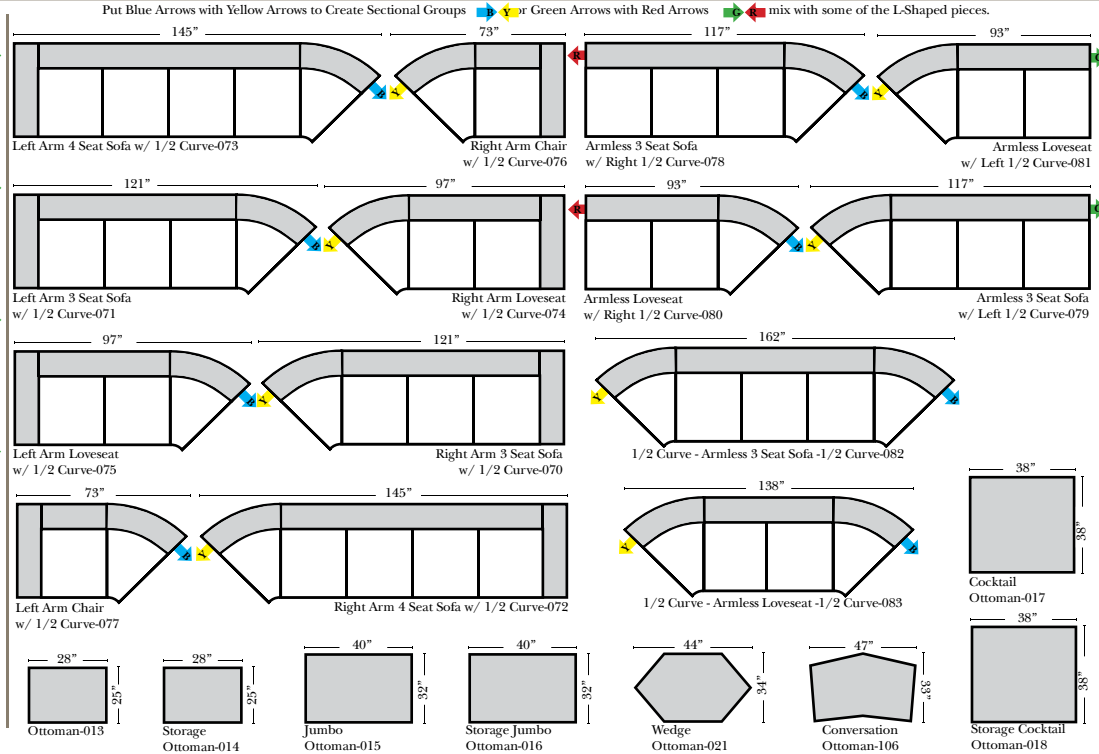

Features

Standard:

- Available in Full & Top Grain Leathers
- Available in Luxury Fabrics
- All Hardwood Frames

Options:

- Down Seats & Backs (additional Charge)
- No. 33 Firm Foam

Sleeper Options:

(No Sleepers available on this style)

L-Shape / 90 Degree Sectional

(All 4 seat items ship as one piece if stationary, two pieces if motion installed)

Put Green Arrows with Red Arrows to Create Sectional Groups

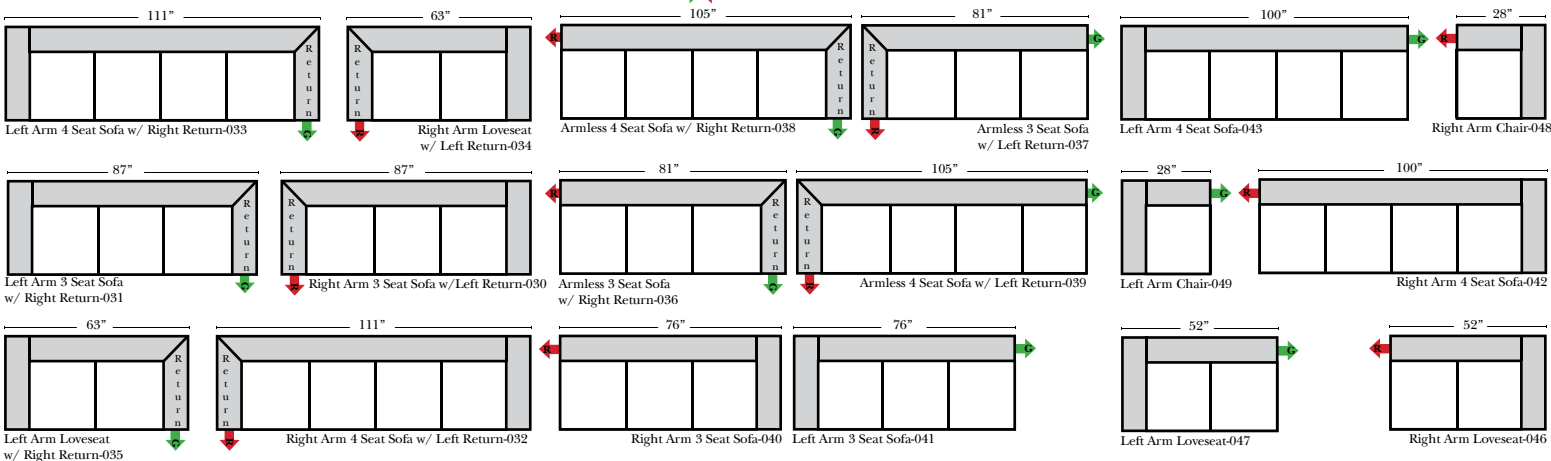



Note:

All Dimensions are approximate, if accuracy is crucial, please contact us for validation of the dimensions shown. However, a 1" to 2" variance can still apply due to foam and upholstery.



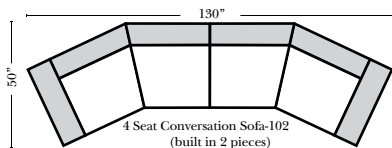
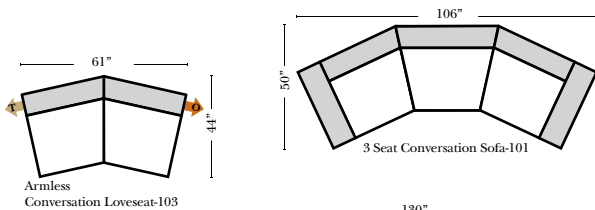
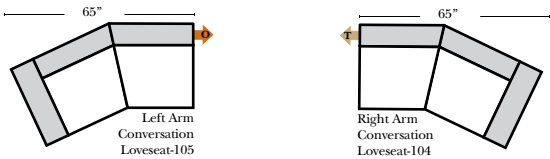
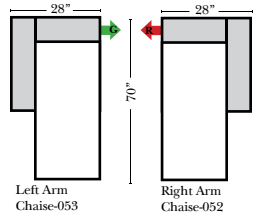

Chaise & Conversation Sectionals

Put Green Arrows with Red Arrows to Create Sectional Groups 
Put Orange Arrows with Tan Arrows to Create Sectional Groups 



Sleepers

Put Green Arrows with Red Arrows to Create Sectional Groups 
Put Blue Arrows with Yellow Arrows to Create Sectional Groups 

Sleepers
for this style not available
at this time

Suggested Configurations

07/06/2012

The Suggested Configurations below are only a sample of what the imagination can create, please enjoy creating the configuration that fits your lifestyle, using the ideas below and from the items on the opposite page.

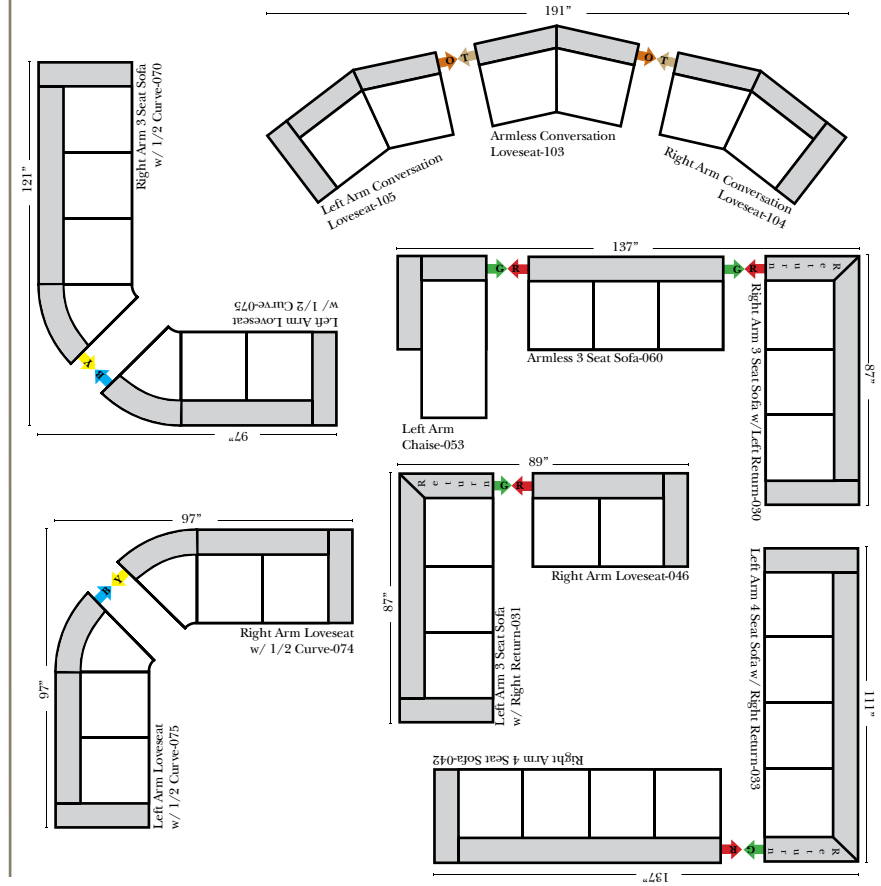

Sleepers (Cont.)