

Standard & Armless

(All 4 seat items ship as one piece if stationary, two pieces if motion installed)

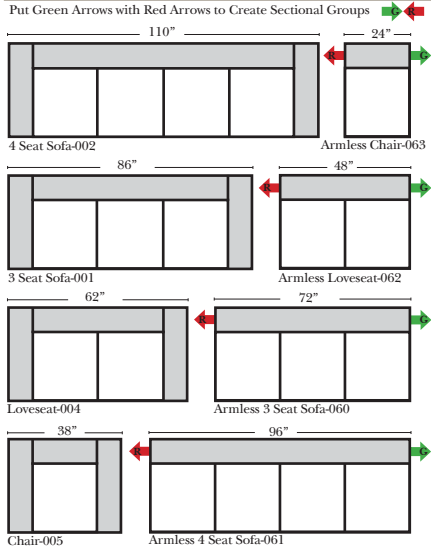

Put Blue Arrows with Yellow Arrows to Create Sectional Groups or Green Arrows with Red Arrows to mix with some of the L-Shaped pieces.

2 Piece Curve Sectional & Ottomans

2 Piece Curve Sectionals
 for this style not available
 at this time

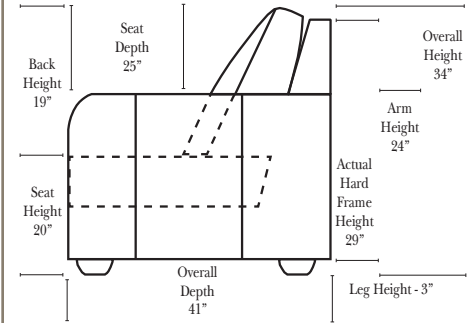
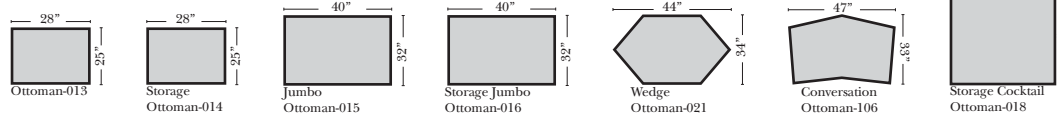

Features

- Standard:**
- Available in Full & Top Grain Leathers
 - Available in Luxury Fabrics
 - All Hardwood Frames

- Options:**
- Down Seats & Down Backs (additional Charge)
 - No. 33 Firm Foam

- Sleeper Options: (All the below options are at additional charges)**
- Queen Sleeper available w/Standard Mattress
 - Twin Sleeper available w/Standard Mattress
 - Deluxe Innerspring Mattress: Queen / Twin
 - Air Dream Coil Mattress: Queen Only
 - Hideaway Air Mattress: Queen Only

L-Shape / 90 Degree Sectional

(All 4 seat items ship as one piece if stationary, two pieces if motion installed)

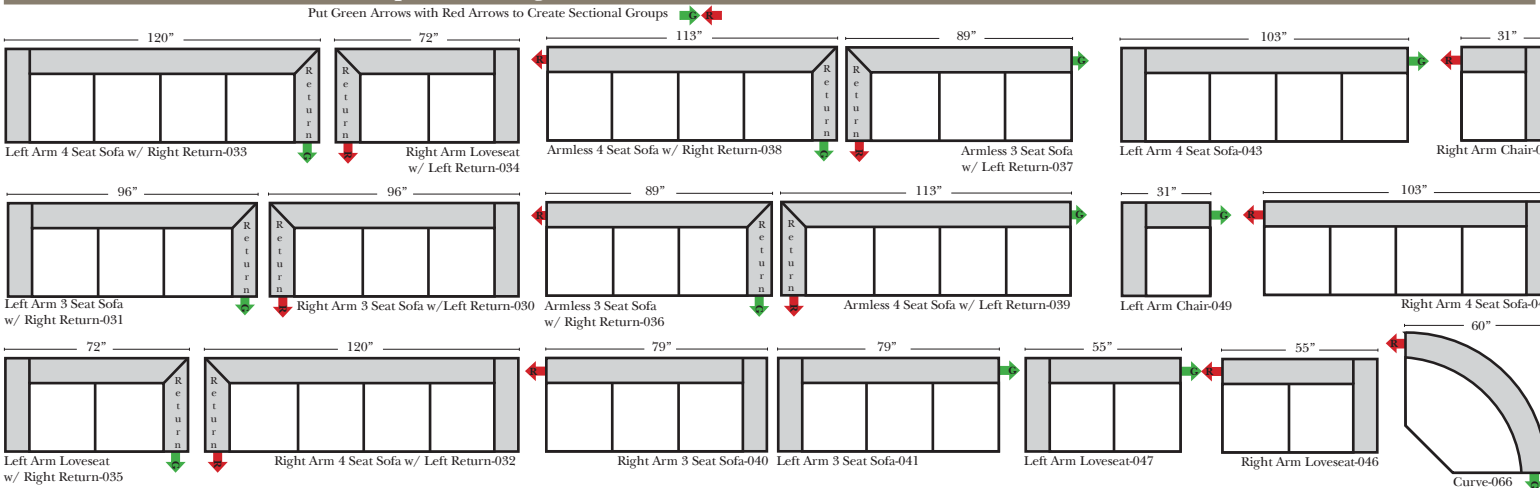

Note:

All Dimensions are approximate, if accuracy is crucial, please contact us for validation of the dimensions shown. However, a 1" to 2" variance can still apply due to foam and upholstery.



Chaise & Conversation Sectionals

Put Green Arrows with Red Arrows to Create Sectional Groups
Put Orange Arrows with Tan Arrows to Create Sectional Groups

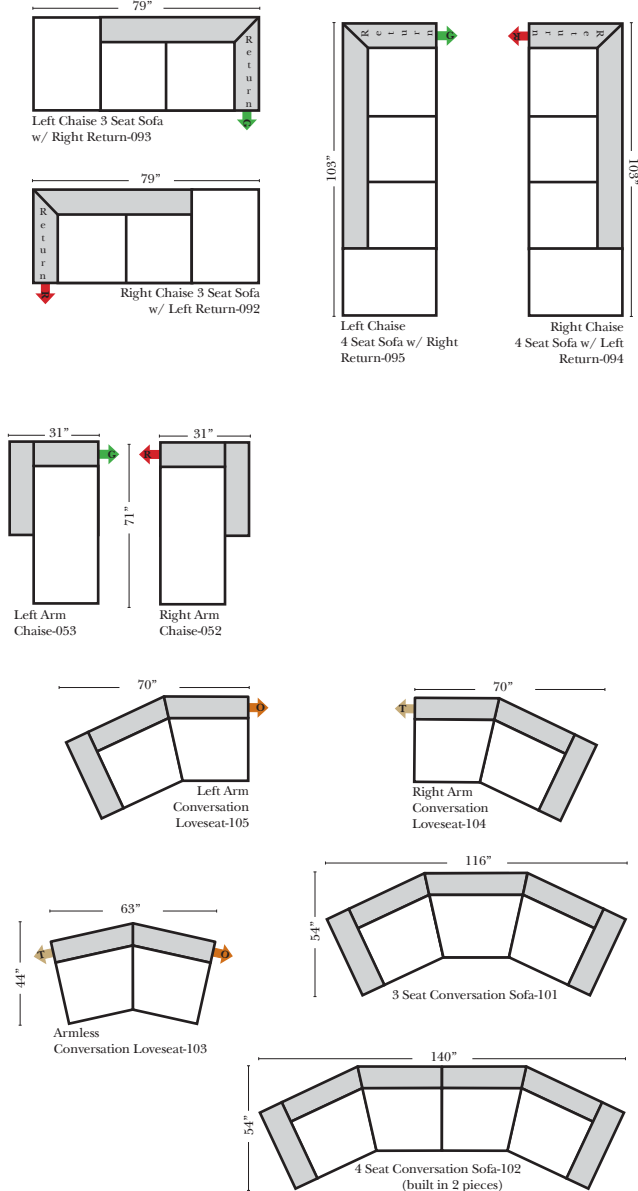

Sleepers

Put Green Arrows with Red Arrows to Create Sectional Groups
Put Blue Arrows with Yellow Arrows to Create Sectional Groups

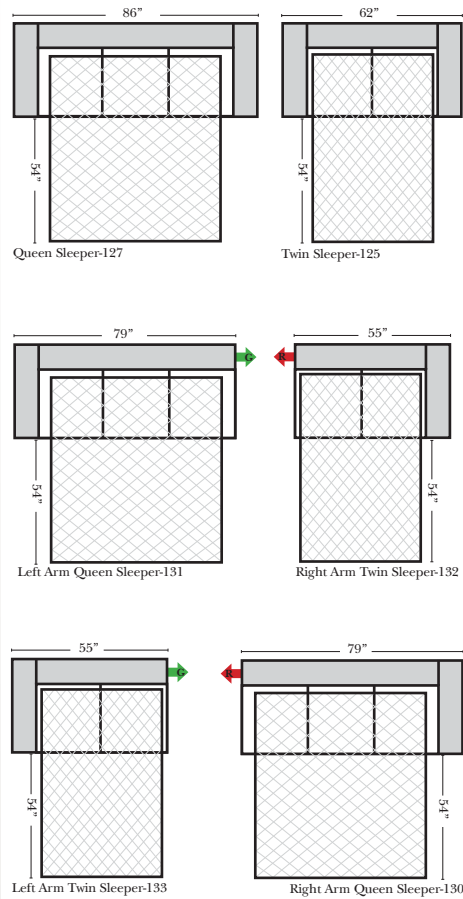

Suggested Configurations

07/06/2012

The Suggested Configurations below are only a sample of what the imagination can create, please enjoy creating the configuration that fits your lifestyle, using the ideas below and from the items on the opposite page.

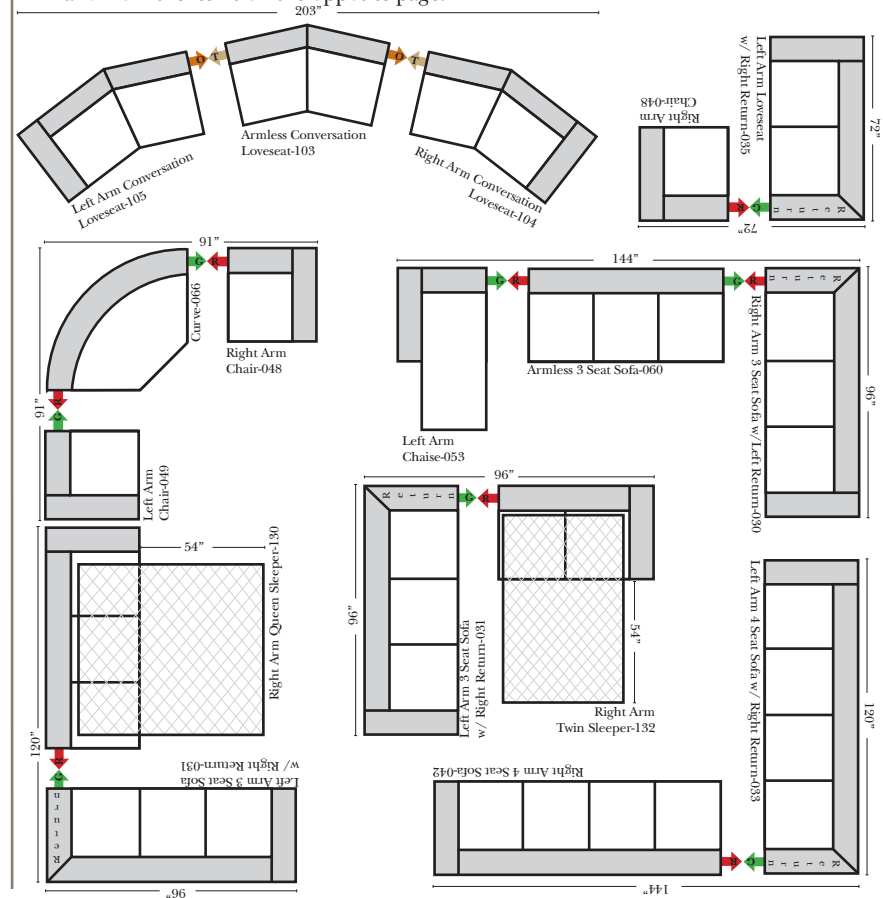

Sleepers (Cont.)