

Personalizing Comfort

07/06/2012

STANDARD

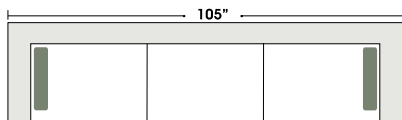

3 Seat Super Sofa

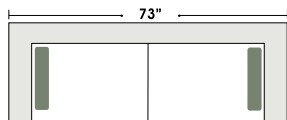

2 Seat Sofa

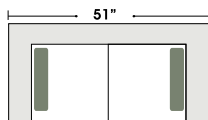

Loveseat

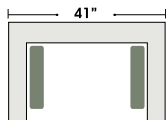

Chair and a Half

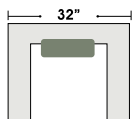

Chair

OTTOMANS

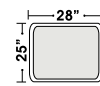

Ottoman

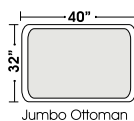

Jumbo Ottoman

1/2 CURVE

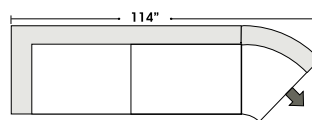

Left Arm 2 Seat Sofa w 1/2 Curve

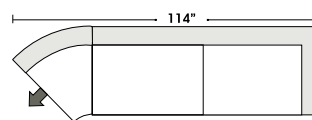

Right Arm 2 Seat Sofa w 1/2 Curve

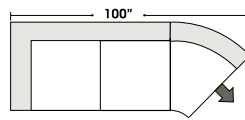

Left Arm Loveseat w 1/2 Curve

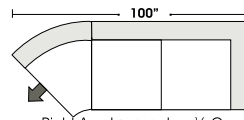

Right Arm Loveseat w 1/2 Curve

Suggested Configurations

Note: the Sectional Diagrams below depict the only way they can be ordered.

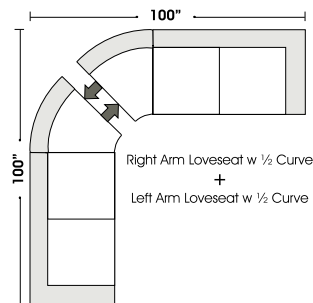
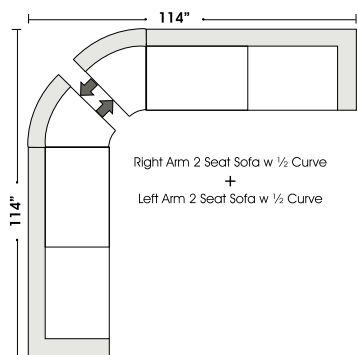

Features

Standard:

- All Full or Top-Grain Leather
- All hardwood frames
- 6" Walnut Leg

Options:

- Down Seats (Additional Charges Apply)
- Down Backs (Additional Charges Apply)

✓ Special orders shipped within 4-6 weeks

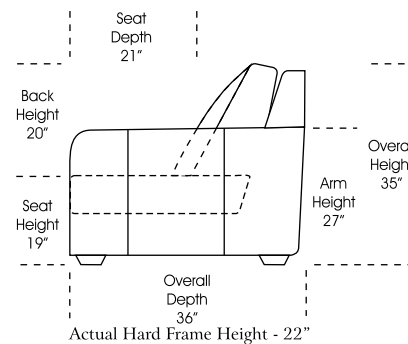

Note: All sizes are approximate.

